

# HOTPOINT SERVICE

SERVICE CALL: If you have a problem with your appliance ring your local Service Office. SPARES and ACCESSORIES: To purchase spares and accessories send your Accessories Order Form to your Service Centre. If the accessory or spare part you want is not on the form then contact your Service Centre for prices and availability. Please address all correspondence to Hotpoint Service Centre or Hotpoint Service Office as applicable.

- Service Office and Service Centre
- Service Office only

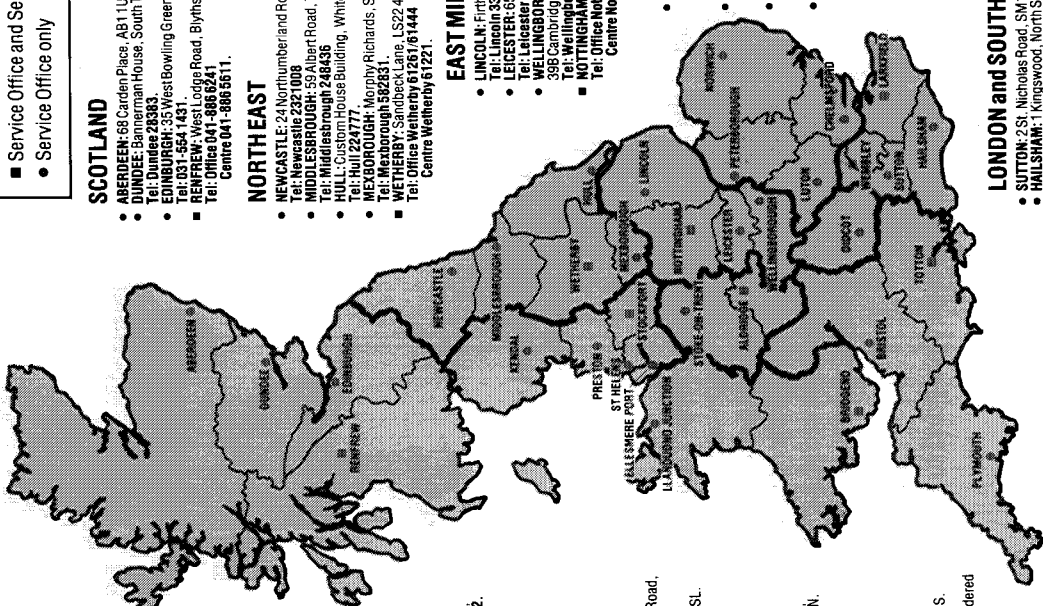

**IRELAND**  
Northern Ireland:  
255 Ormeau Road, Belfast,  
BT7 2ZL.  
Tel: Belfast 647111.  
Eire: 35/36 Arran Quay,  
Dublin 7.  
Tel: Dublin 725922.  
Spares and accessories  
may be ordered from  
either address.

**NORTH WEST**  
● KENDAL: 2B Highgate, LA9 4SX.  
Tel: Kendal 24483.  
● PRESTON: 24/25 Cannon Street,  
PR1 3NR. Tel: Preston 24311.  
● ST. HELENS: 40 Cowley Hill Lane,  
WA10 2AD. Tel: St. Helens 35152.  
● ELLESMERE PORT:  
1 Church Parade, L65 2ER.  
Tel: 051-356 2141.  
● STOCKPORT: 446/450, Station Road,  
Reddish, SK6 3BT.  
Tel: 0161-625 4422.  
Centre 081-432 8255.

**WALES**  
● LLANDUDNO JUNCTION: Conwy Road,  
LL31 9SZ. Tel: Degeany 82826.  
● BRIDGEND: 18 Western Avenue,  
Bridgend Industrial Estate, CF31 3SL.  
Tel: Office Bridgend 64127.  
Centre Bridgend 64127.

**WEST MIDLANDS**  
● STAKE-ON-TRENT: West Avenue,  
Nelson Estate, Kidsgrove, ST7 1TN.  
Tel: Kidsgrove 74511.  
● ALDRIDGE: Westgate, WS9 8UX.  
Tel: Office Aldridge 743374.  
Centre Aldridge 743377.

**SOUTH MIDLANDS**  
● DIDCOT: 224 Broadway, OX11 8RS.  
Tel: Didcot 817711.  
Spares and accessories may be ordered  
from either Aldridge or Wembley  
Centres.

**SOUTH WEST**  
● BRISTOL: 3/5 Brislington Hill, Brislington, BS4 5BQ. Tel: Bristol 714471.  
● PLYMOUTH: 69 Mulley Plain, PL4 6JH. Tel: Plymouth 282651.  
● TOTTEN: South Hampshire Industrial Park, Salisbury Road, SO4 3SA.  
Tel: Office Totton 861981.  
Centre Totton 867933.

**SCOTLAND**  
● ABERDEEN: 68 Carden Place, AB1 1UL. Tel: Aberdeen 642283.  
● DUNDEE: 100 Main House, South Tay Street, DD1 1NR.  
Tel: Dundee 28383.  
● EDINBURGH: 35 West Bowling Green Street, Leith, EH6 5NX.  
Tel: 031-554 1431.  
● RENFREW: West Lodge Road, Blythswood Estate, PA1 9EN.  
Tel: Office 041-886 6241.  
Centre 041-886 5611.

**NORTHEAST**  
● NEWCASTLE: 24 Northumberland Road, NE1 8AJ.  
Tel: Newcastle 232 1008.  
● MIDDLESBROUGH: 59 Albert Road, TS1 1NG.  
Tel: Middlesbrough 248436.  
● HULL: Custom House Building, Whitefriargate, HU1 2EU.  
Tel: Hull 224777.  
● MEXBOROUGH: Morphy Richards, Swinton Works, S64 8AJ.  
Tel: Mexborough 582831.  
● WETHERBY: Sandbeck Lane, LS22 4TW.  
Tel: Office Wetherby 61261/61444.  
Centre Wetherby 61221.

**EAST MIDLANDS**  
● LINCOLN: Frith Road, LN6 7BW.  
Tel: Lincoln 33611.  
● LEICESTER: 65 Belgrave Gate, LE1 3HR.  
Tel: Leicester 299336.  
● WELLINGBOROUGH:  
396 Cambridge Street, NN6 1DW.  
Tel: Wellingborough 220263.  
● TOTTENHAM: 222 St. Paul Street, NG2 3JB.  
Tel: Office Nottingham 862431.  
Centre Nottingham 860387.

**EASTERN**  
● NORWICH:  
92 Upper St. Giles Street,  
NR2 1LL.  
Tel: Norwich 626591.  
● PETERBOROUGH:  
Celia Road, PE2 0JB.  
Tel: Peterborough 64741.  
● LUTON: 5 Gaway Road,  
LU1 1HX.  
Tel: Luton 452211.  
● CHELMSFORD:  
Industrial Buildings,  
Beehive Lane, CM2 9TE.  
Tel: Chelmsford 269331.  
Spares and accessories  
may be ordered from  
Hotpoint Spares  
Administration Dept.,  
Celta Road, Peterborough,  
PE2 9JB. Tel:  
Peterborough 669899.

**LONDON and SOUTH EAST**  
● SUITON: 2 St. Nicholas Road, SM1 1EH. Tel: 01-643 0921  
● HAILSHAM: 1 Kingswood, North Street, BN27 1DD.  
Tel: Hailsham 842733  
● WEMBLEY: 69 East Lane, HA9 7PO.  
Tel: Service Office for S. Herts and Midlands 01-908 1933  
Service Office for London area 01-904 1250  
● LARKFIELD: Larkfield Trading Estate, New Hythe Lane,  
ME20 6SW. Tel: Office Maidstone 75571.  
Centre Maidstone 76631.

# HOTPOINT HANDBOOK FREEZER FRIDGES

Models 8633 & 8634

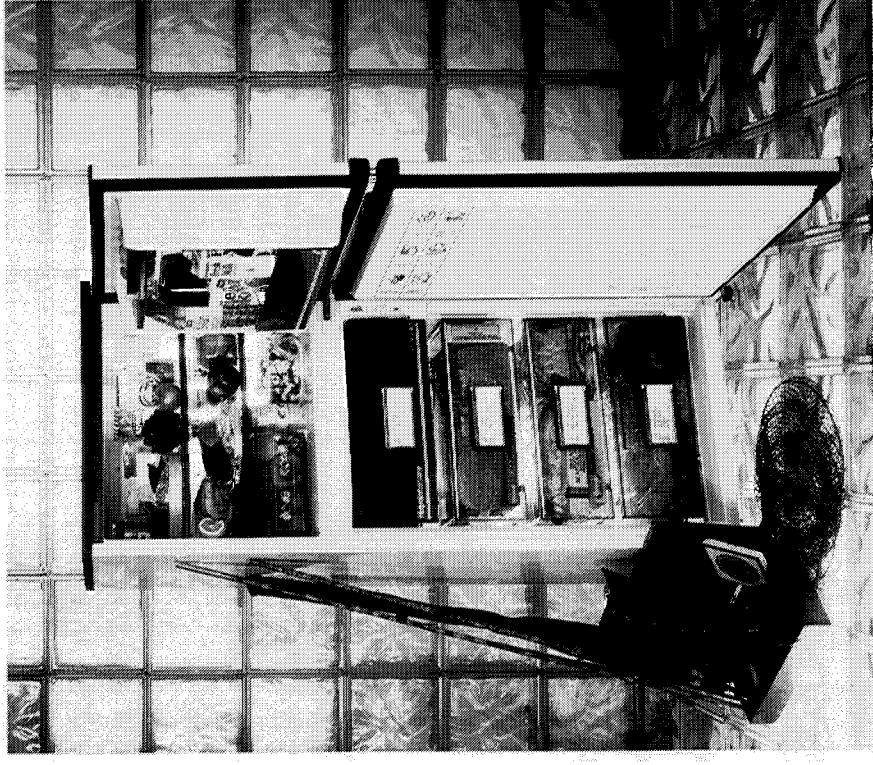

# Hotpoint®

WARNING: Avoid accidents to children. When discarding an old fridge or freezer be certain to make the lock unusable.

In accordance with its policy of progressive product design, the Company reserves the right to alter specifications.

# Your new Hotpoint Freezer Fridge

Using your new freezer fridge is very simple. Nevertheless, to get the best results it is important that you read right through this handbook **before** using your freezer fridge for the first time. Do not load the freezer compartment immediately the freezer fridge is switched on, but wait until the correct storage temperature has been reached (see page 9).

## Electrical Requirements

We recommend that this appliance is connected to the mains supply via a suitable switched socket in a readily accessible position.

All Hotpoint appliances come complete with a fitted plug. The plug on your freezer fridge has a 13A fuse. If the plug does not fit your sockets, a new plug can be fitted. Cut off the old plug and throw it away, do not insert it into a socket elsewhere in the house as this could cause a shock hazard.

### **WARNING: THIS APPLIANCE MUST BE EARTHED.**

#### **IMPORTANT: Fitting a Different Plug:**

The wires in the mains lead are coloured in accordance with the following code:

Green and Yellow	– Earth
Blue	– Neutral
Brown	– Live

If you fit your own plug the colours of these wires may not correspond with the identifying marks on the plug terminals. This is what you have to do:

1. Connect the green and yellow (Earth) wire to the terminal in the plug marked 'E' or with the symbol , or coloured green or green and yellow.
2. Connect the blue (Neutral) wire to the terminal in the plug marked 'N' or coloured black.
3. Connect the brown (Live) wire to the terminal marked 'L' or coloured red.

With alternative plugs a 5A fuse must be fitted either in the plug or adaptor or in the main fuse box. In the event of replacing a fuse in the plug supplied, a 13A ASTA approved fuse to BS1362 must be fitted.

If the plug is the moulded on type the fuse cover must be refitted when changing the fuse. In the event of losing the fuse cover the plug must **not** be used until a replacement fuse cover has been obtained and fitted. A new fuse cover can be obtained from your nearest Hotpoint Service Centre or local Electricity Board. The colour of the correct replacement fuse cover is that of the coloured marks or insert in the base of the plug.

#### **Mains Lead Replacement**

If the supply cord on this appliance is damaged, it must be replaced by a special cord which is obtainable from your nearest Hotpoint Service Centre (see back page).

# Five Year

From the moment your freezer fridge is delivered, Hotpoint guarantees it for FIVE YEARS.

During the five years all parts are completely free of charge, provided they are fitted by Hotpoint's own Service engineer. Labour costs are chargeable after the first year.

Our FIVE YEAR GUARANTEE also covers loss of food up to £250 in the first year.

This guarantee does not cover accidents, negligence or power cuts. The freezer fridge must be used in the United Kingdom and must not be used by anyone who is not an authorised Hotpoint Service engineer. This way limits your legal rights.

#### **Iced Diamond Plan**

At the end of the first year an annual payment provides free of charge cover up to £250 throughout the five year period.

If you wish to enjoy the benefits of the Iced Diamond Plan, please register your registration card and send it, together with the payment, to your nearest Hotpoint Service Office.

#### **Proof of Purchase**

For future reference please retain your receipt and keep it in a safe place.

# If your Freezer Fridge won't work

... don't panic

Just run through these quick checks before calling your local Hotpoint Service Office.

1. Check that the plug is firmly in the wall socket and that the power supply is on.
2. Check the power supply to the socket by plugging in another appliance.
3. If the other appliance works, check the fuse in the freezer fridge plug.
4. If you have changed the plug, check the wiring (see page 2).
5. If there is excessive noise or vibration, check that all four feet are firmly in contact with the ground (see page 5).
6. If the interior light fails to work, refer to page 17 for further instructions.
7. If water appears down the inside back of the fridge compartment, check that the gutter drain hole has not become blocked or that there is nothing touching the cooling plate. (**NB** Water droplets on the cooling plate are quite normal.)
8. If water droplets appear on the outside of the cabinet, check that you have the Economy switch set on 'H' (see page 10).
9. You may find the freezer compartment door difficult to open just after you have used it. This is due to a pressure difference which will soon equalise. Wait a few minutes then open the door.

If, after following all these instructions, you are still having problems, contact your nearest Hotpoint Service Office (or local importer if outside the United Kingdom). The telephone number is shown on the back page.



When you contact us we need to know:

1. Your name, address and post code.
  2. Your telephone number.
  3. Clear and concise details of the fault.
  4. The model number (8633 or 8634), and colour.
  5. When it was purchased. Please put the date here .....
  6. If you have subscribed to the Hotpoint Iced Diamond Plan (see opposite page).
- Make sure you have all these details before you call.



## Contents

**THIS BOOK CO**

**Get to know your**

**Installing your Fr**

Where to put you  
Fitting decor pan  
Repositioning the

**Getting your Free**

Starting and Run

**The Controls .....**

Controlling the t  
Economy switch

**Storing Food .....**

Storing food in th  
Storing frozen fo  
Freezing fresh fo  
to freeze them  
Do's and Don'ts

**Caring for your F**

Defrosting  
Cleaning  
Going Away  
Replacing the int

**If your Freezer Fr**

Five Year Guarar

# Get to know your Freezer Fridge

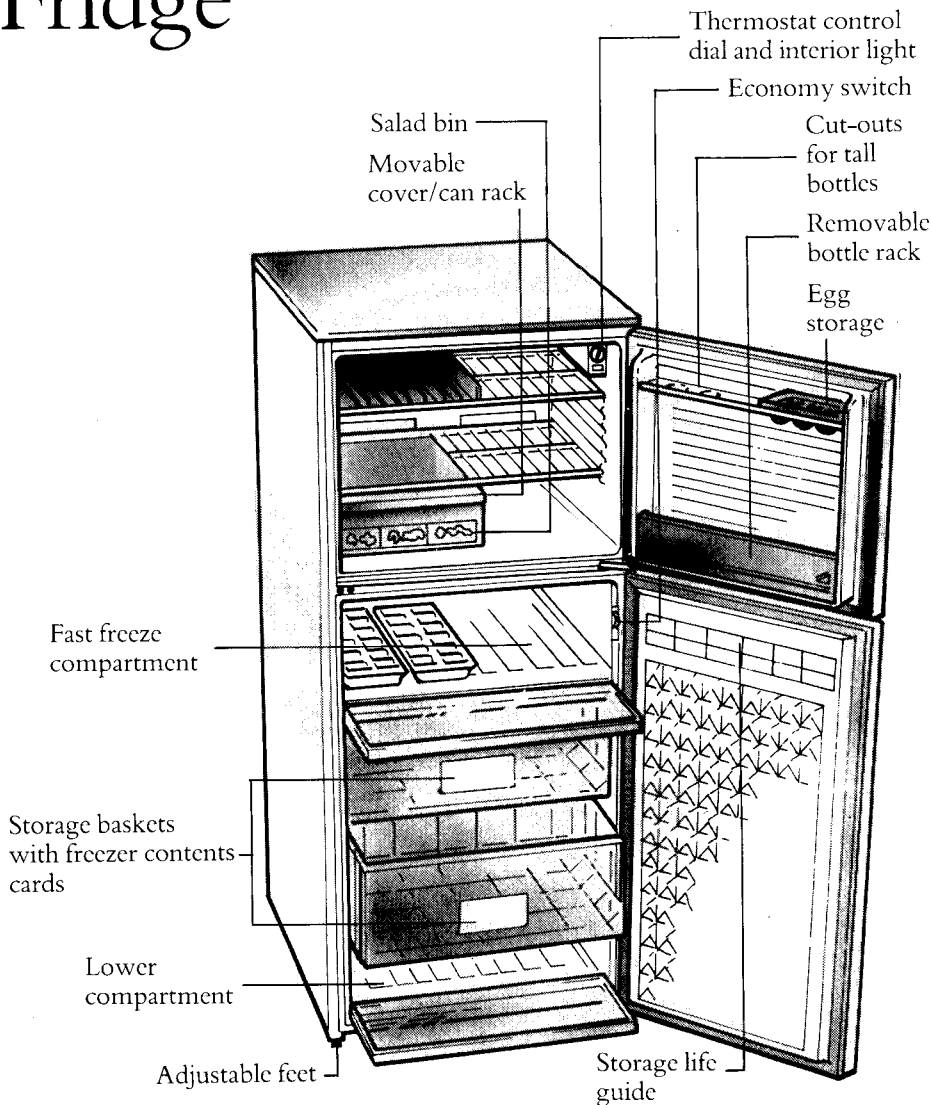

**Model 8633**

(Model 8634 is similar, but does not have Freezer Contents Cards in the freezer.)

## Going away

If you expect to be away for any length of time and don't want to use your freezer fridge, switch off at the power point and pull out the plug. Remove all food and follow the defrosting instructions (see page 15). After defrosting dry out the interior. Always leave both doors ajar to prevent the accumulation of odours.

## How to replace the light

Should the light fail to work, then ensure the bulb is screwed in correctly and switch on.

If the light still fails to work, contact your freezer fridge. Obtain a replacement bulb from an electrical retailer or your nearest hardware store. Follow the following steps:

1. **Switch off and pull out the plug.**
2. Remove the wire shelves from the freezer compartment.
3. Slacken off the lamp guard by turning the screw one turn.
4. Unclip and remove the lamp guard.
5. Unscrew the old bulb and discard it.
6. Refit the lamp guard, ensuring the screw fits into the holes.
7. Retighten the retaining screw.
8. Replace the plug and switch on the freezer fridge.

# Caring for your Freezer Fridge (cont.)

Defrosting must be carried out as quickly as possible since a rise in the temperature of your frozen food may reduce the recommended storage time. Just follow these steps:

1. **Switch off and pull out the mains plug.**
2. Remove any frozen food. Wrap it in several layers of newspaper or a blanket and put it in the fridge compartment or a cool place.
3. Place bowls of hot water in the fast freeze compartment and lower compartment.
4. As soon as the frost begins to melt use the plastic scraper to chip it off.
5. Sponge out the defrost water which collects in the bottom of the freezer.
6. After defrosting, remove the bowls and dry the interior thoroughly.
7. Replace the mains plug and switch on. Unwrap the frozen food and replace. Close the door.
8. Job done!

## Cleaning your freezer fridge

It is a good idea to clean the inside of your freezer fridge after defrosting. Always **switch off and pull out the mains plug** first. Wipe out the inside of the freezer fridge using a clean cloth wrung out in either a solution of one teaspoonful of bicarbonate of soda to one pint of water or Milton diluted according to the manufacturer's instructions. The complete interior including the door, and removable parts, should be washed. Never use any household cleaner or detergent, abrasive powders or wax polish. These not only damage the surfaces, but also leave a smell in the freezer fridge. Make sure that no particles of food are left in the gutter in the fridge compartment. Before you refill the freezer fridge ensure it is thoroughly dry.

Clean the outside of the freezer fridge, **but not the door seal**, with a damp cloth, using a small amount of detergent, followed by a wipe down with a clean cloth. Do not use an abrasive powder. **The rubber door seal must be cleaned with soap and water only as detergent will damage it.**

Finally, the compressor and condenser at the back of the freezer fridge can be carefully cleaned. Use a brush or vacuum cleaner to remove any dust. Always check that the freezer fridge is disconnected from the mains when doing this.

Remember to replace the mains plug and switch on after cleaning your freezer fridge.

# Installing your Freezer Fridge

## Where to put your freezer fridge

Your freezer fridge should be placed on a hard, level work surface is often a good position. A radiator which gives off heat, a cooker or a sink which has an air gap of 10mm (1/2") must be left between the fridge. In such a position your freezer fridge will run more efficiently.

Do not put your freezer fridge in a room which goes below 6°C (43°F) for prolonged periods. The compartment will run warmer and will wear out more quickly.

Once you have decided on a position, the condenser coils should be supplied to the top of the condenser. The particular type of condenser – your choice of alternative condensers (a) or (b) as shown in the diagram – until the spacers are against the wall. This ensures air circulation at the back of the freezer fridge.



If your freezer fridge is placed in a room where there is a gap of at least 38mm (1 1/2") between the back of the freezer fridge and the underside of the cupboard above it, this will ensure good air circulation.

Finally, make sure your freezer fridge is level. The two front feet should be adjusted until all four feet are on the floor. This adjustment avoids excessive vibration.

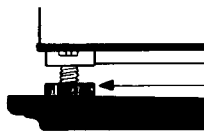

A Wheel Kit, Part No. 803 is available from your retailer or direct from the manufacturer. Order Form supplied.

## Fitting decor panels to match your kitchen units

For that fully co-ordinated kitchen look it is possible to fit matching decor panels to your freezer fridge. Special trim kits are available from Hotpoint that attach to the edges of the appliance doors and enable decor panels, up to 4mm (1/8in) thick, to be fitted. Decor panels are available from most kitchen suppliers.

Each door requires a separate trim kit:

Top door requires trim kit Part No. 8003 (Brown) or Part No. 8006 (White).

Bottom door requires trim kit Part No. 8001 (Brown) or Part No. 8004 (White). These are available from your retailer or Hotpoint Service Centre (see back page) using the Accessories Order Form supplied with your Freezer Fridge.

## Repositioning the door hinges

Just follow the step by step instructions below:

**Tools Required:** A 7mm/8mm A/F Spanner or a No. 2 Pozidriv.

1. Take out all the loose fittings such as shelves, drinks chiller and salad crisper from the inside of the freezer fridge.
2. **Carefully** lay the freezer fridge on its back (you may need assistance to do this) onto the original packing. **Take care to avoid damage to the pipework by keeping it clear of the floor.**
3. Unscrew and remove the two front feet (1).
4. Remove the clamping plate (2) and bottom hinge (3) by unscrewing the two screws (4). Make sure that if any packing washers (5) are fitted they are left on the hinge pin.
5. Remove the bottom screws (6), washers and plate (7) and fit them on the opposite side of the cabinet, making sure the hole in the cabinet for the foot is not covered over.
6. Remove the bottom door, gently pulling it downwards until clear of the centre hinge.
7. Remove the centre hinge (8) by unscrewing the two screws (9). Keep any packing washers (10) and any packing pieces (11) if fitted.
8. Remove the top door, gently pulling it downwards until clear of the top hinge.
9. Remove the top hinge (12) by unscrewing the two screws (13) – replace the screws (13) but not the washer (14). Make sure the screw heads do not protrude below the recess.
10. Remove the two screws (15) in the opposite recess and use them to fit the top hinge (12), with the washer (14) on top, in the recess. Tighten the screws so that they are just gripping the hinge.
11. Carefully prise off the two plastic caps (16) from the transom between the two compartments and remove the two screws (17) and collars (18) underneath. Refit the collars, screws and caps on the opposite side of the transom.
12. Before refitting the doors, the plugs (19) and hinge bushes (20) at the

# Caring for Fridge

## Defrosting:

### The fridge compartment

The fridge compartment will drain out through the hole where it evaporates. Water droplets during defrost periods and will freeze on to the coils. Do not **exceptionally** warm the cooling coils. Do not worry. Periodic defrosting will be sufficient.

Do make sure that the gutter does not come into contact with the coils.

### The freezer compartment

Excessive frost build-up reduces the efficiency of the fridge so from time to time chip off the frost. You do not need to switch off the power supply.

**Never** use sharp metal tools to defrost the freezer compartment.

When the ice becomes about 25mm thick, completely defrost the freezer compartment. Do this about once or twice a year, or more often if there is little or no food in the freezer.

# Do's and Dont's (cont.)

## DON'T

### Fridge compartment

- Store bananas in the fridge compartment.
- Store melon in the fridge compartment. It can be chilled for short periods as long as it is wrapped to avoid it flavouring other food.
- Wash eggs as this removes their natural protective film. Wipe them instead.
- Use eggs straight from the fridge compartment, especially when making cakes or mayonnaise. Allow them to reach room temperature before use.
- Leave the door open for long periods as this will make the fridge compartment more costly to run.
- Cover the shelves with any protective materials which may obstruct air circulation through them.
- Let anything touch the cooling plate at the back of the fridge compartment.

### Freezer compartment

- Exceed the maximum freezing loads when freezing fresh food (see pages 11 and 12).
- Put hot food into the freezer or even in the fridge compartment. Let it cool down first.
- Leave the door open for long periods as this will cause excessive ice formation and make the freezer compartment more costly to run.
- Put liquid-filled bottles or sealed cans containing carbonated liquids (fizzy drinks, etc) into the freezer compartment as they may burst.
- Try to keep frozen food which has thawed; it should be eaten within 24 hours or cooked and refrozen.
- Give children lollipops and water ices direct from the freezer compartment. The low temperature may cause 'freezer burns' on their lips.



top and bottom of both doors in the same locations taking care not to mark the opposite side of each door.

13. Reposition the door handle on the door. To do this, remove the screws.

14. Refit the top door by locating the top hinge pin. If necessary, adjust the door so that it fits evenly.

15. Fit one of the two bolts on the opposite side and screw halfway through the hinge bush (20) at the bottom of the door. Fit the washers (10) if fitted, on the pin,

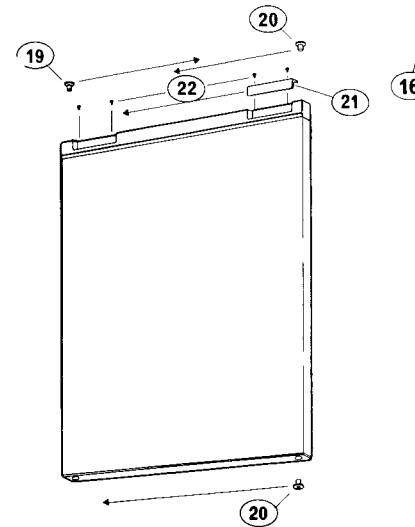
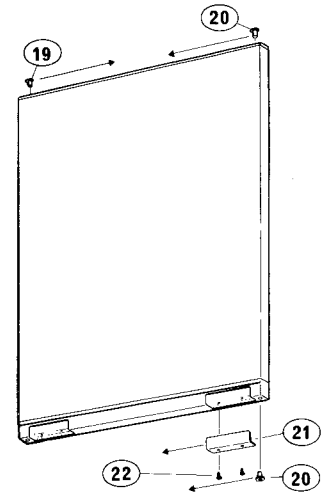

### Repositioning the door hinges (cont.)

16. Put any packing pieces (11) that may have been originally fitted between the centre hinge and the cabinet and screw the hinge to the cabinet with the two bolts (9).

17. Refit the bottom door by laying it on the cabinet and, sliding it upwards, locate the top hinge bush on the centre hinge pin.

18. With all the packing washers (5) that may have been originally fitted retained on the pin, fit the bottom hinge pin (3) into the bottom hinge bush (20). Adjust as necessary so the door fits evenly.

19. The bottom hinge can now be secured to the cabinet using the clamping plate (2) and two screws (4). The clamping plate should be fitted with the straight side facing the outside edge of the cabinet and the large hole towards the rear of the cabinet.

20. Replace both adjustable front feet (1) setting them at approximately 35mm (1 3/8") from the bottom of the cabinet.

21. Carefully stand the freezer fridge up (you may need assistance to do this) and put it where you have decided to locate it. Ensure it is standing correctly by adjusting the two front feet until all four feet are in firm contact with the floor.

22. Check the doors open and close easily. **Ensure the door seals do not bind on the hinge side and that there are no gaps allowing air into the cabinet.** Adjust the hinges if necessary.

23. Tighten the hinge screws.

24. Finally, put back all the loose fittings inside the freezer fridge.

## Getting your Freezer Fridge ready for use

Before using your freezer fridge for the first time the interior, including the door, and all removable parts should be wiped out. Use a damp cloth wrung out in either a solution of one teaspoonful of bicarbonate of soda to one pint of water or Milton diluted according to the manufacturer's instructions.

**WARNING:** Never use any household cleaner or detergent, abrasive powders or wax polish. These not only damage the surfaces, they also leave a smell in the freezer fridge.

## Do's and Don'ts

### DO

#### Fridge compartment

- Take off any unusable leaves
  - Leave lettuce, cabbage, potatoes
  - Wrap cheese tightly in cling film
- For the best results take out of the fridge compartment
- Wrap raw meat and poultry
- This prevents drying.
- Wrap fish and offal in polythene
  - Wrap foods which have a high water content in bags, aluminium foil or place in airtight containers
  - Wrap bread well to keep it soft
  - Chill white wines, beer, lager
  - Make sure the gutter at the bottom is clear. Remove any particles of food

#### Freezer compartment

- Always choose high quality fresh food and clean before you freeze it.
  - Prepare fresh food for freezing
  - Remember lean foods last longer than fatty storage life.
  - Wrap all foods in aluminium foil so air is excluded. Keep the door shut as long as possible.
  - Separate food in different compartments
  - Wrap frozen food when you have space in the compartment as soon as possible.
  - Empty and refill the ice tray
  - Store commercially frozen food in the compartment given on the packets that you buy.
  - Defrost the freezer compartment
- 15).



# Storing Food (cont.)

5. Reset the Economy switch to 'E' when freezing is complete.

## Freezing up to 12kg (26.5lb)

1. It is not necessary to alter the control setting. If your freezer fridge has not been in use follow the instructions given under Starting, page 9.
2. Transfer any frozen food from the fast freeze and lower compartments to the storage baskets.
3. Press 'H' on the Economy switch to avoid condensation on the outside of the freezer.
4. Put 8kg (17.5lb) of fresh food into the fast freeze compartment and the remainder in the lower compartment with as much food as possible in contact with the compartment floors.
5. Reset the Economy switch to 'E' after 24 hours.



## Freezer contents cards (Not Model 8634)

Use a soft pencil to itemise both the contents of the freezer compartment and the 'use by' dates. Use a soft rubber to remove the writing.

## Final check

- Before you start using the
1. it is thoroughly dry inside
  2. air can circulate freely,
  3. the feet have been adjusted

## Starting

Insert the plug into the wall socket. Open the freezer compartment door and the right hand side of the interior door. This will start the freezer fridge working. The lights will come up. A control setting of 4-5 is usually recommended.

If you are going to store already frozen food in the freezer compartment to reach the required temperature, put in the frozen food.

If you are going to freeze fresh food, allow it to be frozen for **least three hours** before putting it in the freezer compartment. Do not put more than 12kg (26.5lb) of fresh food in the freezer compartment.

## Running-in the compressor

Your freezer fridge is operated by a compressor which switches on and off in order to maintain the freezer fridge's temperature. The compressor is a precision piece of machinery and requires a running-in period of up to 24 hours. At this time the compressor has to work hard and this may result in more noise than normal.

## The Control Dial

### Controlling the temperature

The control dial, on the right hand side of the interior, controls the temperature of the freezer compartment at the control dial setting of 3 .... 9.

Which setting is selected will depend on the location, how often you open the freezer compartment.

A control setting of 4-5 is usually recommended. If the freezer compartment is too warm (higher number). Similarly, if you find the freezer compartment is too cold (warmer setting (lower number)).

**Repair Service**

UK: 08709 066 066

(Open 8 to 8 Mon - Fri, 8 to 6 Sat & 10 to 4 Sun)

[www.theservicecentre.co.uk](http://www.theservicecentre.co.uk)

Republic of Ireland: 1850 302 200

Note: Our Service Operators will require the following information:

Model Number

Serial Number

**Extended Warranties**

UK: 08709 088 088

(Open 8 to 6 Mon - Fri)

[www.theservicecentre.co.uk](http://www.theservicecentre.co.uk)

Republic of Ireland: 1850 502 200

**Genuine Parts and Accessories**

UK: 08709 077 077

(Open 8-30 to 5-30 Mon - Fri, 8-30 to 12 Sat)

[www.theservicecentre.co.uk](http://www.theservicecentre.co.uk)

Republic of Ireland: (01) 842 6836

General Domestic Appliances Limited, Morley Way, Peterborough, PE2 9JB